

SPECIFICATION SHEET

ML-30-WT

Milano 30" Single Sink Vaniy

PARTS LIST

PART #	DESCRIPTION
A	Backsplash
B	Countertop
C	Basin
D	Flip down panel
E	Door (left)
F	Door (right)
G	Drawer Handle
H	Door Handle
I	Hinge
J	Drawer glides

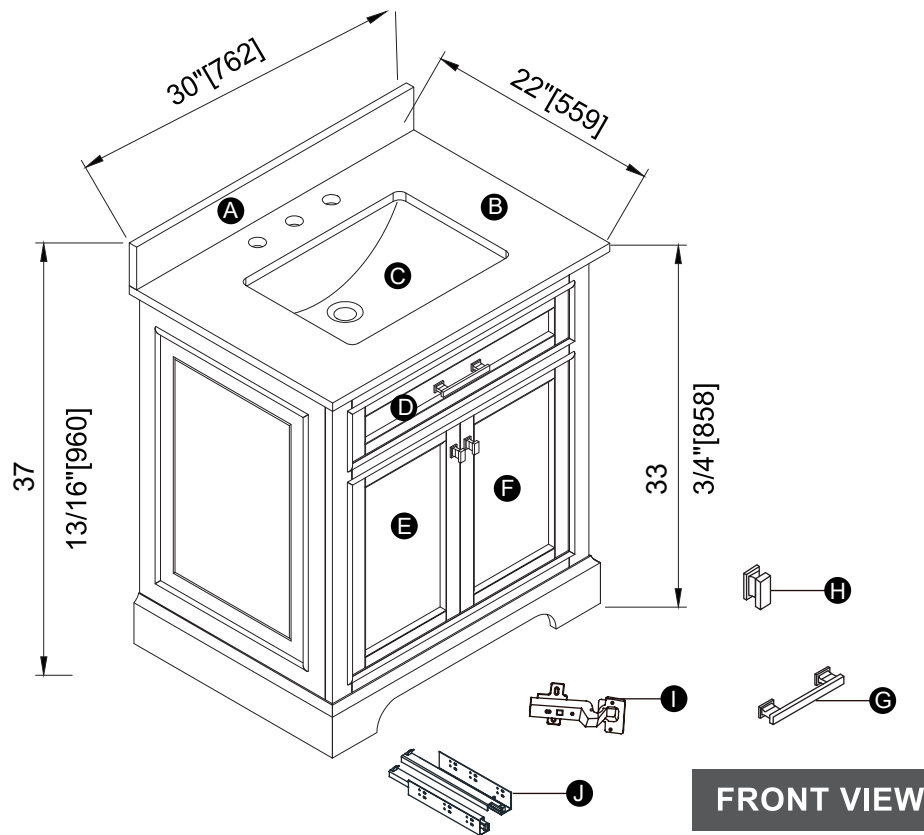

FRONT VIEW

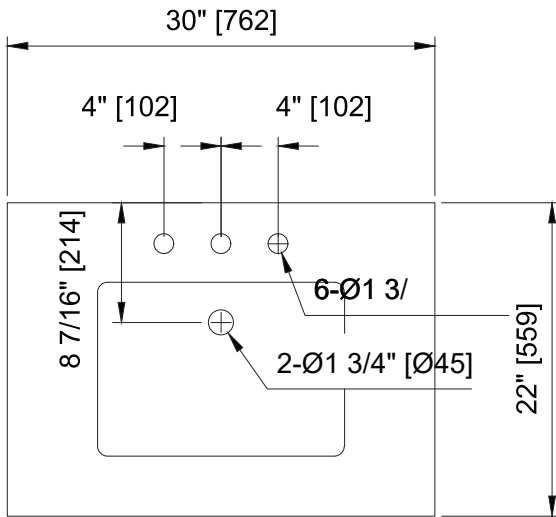

TOP VIEW

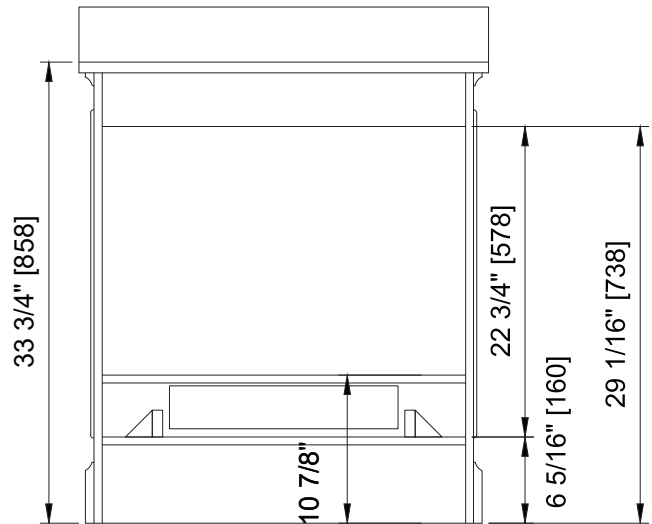

BACK VIEW

NATURAL STONE DISCLAIMER

The purchaser acknowledges that the countertop is made of natural stone, no two pieces of are exactly alike. They are prone to variations in color, texture, shade and veining, which are not to be considered as a defect. Design Element does not warranty natural stone products for shade coloration, size/ thickness variation, clefting, nor surface finish variation.

WARRANTY

DESIGN ELEMENT warrants the Product to be free from defects in workmanship and materials under normal use and service for a period of one (1) year from the initial date of purchase by the owner or end-user, contractor, or builder, from DESIGN ELEMENT or an authorized DESIGN ELEMENT dealer. The original purchase receipt must be provided to DESIGN ELEMENT for all warranty claims.

CONTACT SUPPORT

Email: cs@designelementusa.com
 Phone: TOLL-FREE 888-487-4488 (9AM-5PM PST | MONDAY TO FRIDAY)
 8715 Boston Place, Rancho Cucamonga CA, 91730



DESIGN
ELEMENT